

PLATINUM

October 2017

Rooming Accommodation

Mastermind Event

Brisbane

Tamara Read

QLD State Coach



I LOVE
REAL ESTATE

Event Outline -

- 6:00 – 6:30 Networking
- 6:30 - Start
- 6:30 – 6:45 Introductions
- 6:45 – 8:00 Accountability
- 8:00 – 8:30 Networking Break
- 8:30 – 10:00 Rooming Accommodation – Plan Reading & Modification

Workshop Format

- Use microphone
- Involve everyone in the conversation
- Be supportive



Housekeeping

Platinum Namaste – Graduate Bali 4 Day Retreat

- ❖ 10th Dec – 13th Dec
- ❖ Novotel Nusa-Dua
- ❖ **Unique activities** - 5 yr Cocktail Party; 2 Day Conferencing, 1 Day Outside Experiential Activities, Gala Dinner
- ❖ **RSVP** – 10th Nov
- ❖ **Passport** – Must have 6 months valid on your passport



Housekeeping

- **Platinum Graduate Offer** (Inc. Platinum *Namaste* Bali:
 - ❖ **Part Payment Option:** Re-join within 30 days of expiry date @ \$1250 x 12 payments
 - ❖ **Payment in Full** = \$12,995
 - ❖ **Partner Option** Pay in Full Only = \$4,995
 - ❖ **Re-application** Process

- **I Love Real Estate Super Conference - Annual Success Story Competition – Closes 20th Oct:** All Platinum Accelerator students are encouraged to submit their story. Awesome prizes on offer!!

Housekeeping

- **December PA National Conference:** 2nd – 3rd Dec, Sydney, RSVP with Knowledge Source - Open bar evening of Fri 1st & Networking dinner evening of Sat 2nd.
- **Ultimate Bootcamps:**
 - ❖ Sydney 6th – 8th Oct
 - ❖ Gold Coast 13th – 15th Oct
 - ❖ Melbourne 21st – 23rd Oct
 - ❖ Perth 27th - 29th Oct
- **Seminars:**
 - ❖ Fast Profits / Extreme Income – Gold Coast 2nd – 5th Nov
 - ❖ I Love Realstate Conference – Brisbane 17th – 19th Nov

Housekeeping

iLove Real Estate Professionals

WIZDOM:

WIZDOM

Accountants | Finance Strategists | Advisors

info@wizdom.com.au
1300 949 366

PACIFIC LAW
info@pacificlaw.com.au

1300 151 651

Business Law
Conveyancing
Succession Planning
Estate Planning, Wills, Power of Attorney
Property Development and Joint Ventures

WIZDOM Loans

loans@wizdom.com.au

1300 949 366

Complex Loan Structuring and Advice
Development/Commercial Finance
Finance Strategy and Support
Home Loans/Refinances
Investment Lending
SMSF Lending

WIZDOM Advisory

advisory@wizdom.com.au

1300 949 366

Superannuation Advice and Consolidation
SMSF Set Up and Implementation
Retirement and Cashflow Advice
Ongoing SMSF Strategy Advice
Personal Risk Insurance
Estate Planning

WIZDOM Accounting

accounting@wizdom.com.au

1300 949 366

Tax Return Preparation and Lodgement
Bookkeeping and Cloud Accounting
Property and Business Tax Advice
SMSF Compliance and Audit
Year End Tax Planning
Strategic Planning



INVESTOR PACIFIC STRUCTURES

info@investorpacificstructures.com.au

1300 151 651

IPS is a jointly owned business between Pacific Law and WIZDOM Accounting. IPS provides you with both Legal and Accounting structuring advice.

IPS also completes the Company, Investment Trust, Business Entity, Piggy Bank Trust & Bucket Company set ups.

PLATINUM



I LOVE
REAL ESTATE

.....
Life is 10% what
happens to us
and 90% how we
react to it.
.....

-Dennis P. Kimbro



Questions to Discuss

- What makes someone a good athlete? **Eg. Usan Bolt**
- Or a good leader? **Eg. If you google best leader in history you get – Abraham Lincoln, Barak Obama, Nelsen Mandela, Mahatma Gandhi, Mao Zedong, Churchill and Hitler**
- Or a good parent? **You fill in the blank**
- Or a good real estate investor or developer? **Harry Trigaboffen**
- Why do some people accomplish their goals while others fail?
- Are your answers to the above questions different for each one?

- Usually we answer these questions by talking about the talent of top performers.
 - *He is the most talented*
 - *He is the smartest*
 - *He is the best at*
- But I think we all know there is more to the story than that.
- In fact, when you start looking into it, your talent and your intelligence don't play nearly as big of a role as you might think. The research studies that I have found say that intelligence and talent only accounts for 30% of your achievement — and that's at the extreme upper end.
- So what makes a bigger impact than talent or intelligence?

Mental toughness

- Each year, approximately **1,300 cadets** join the entering class at the United States Military Academy, West Point. During their first summer on campus, cadets are required to complete a series of brutal tests
- Angela Duckworth, a researcher at the University of Pennsylvania, **conducted a study tracking the cadets.**
- In Duckworth study she **tracked 2441 cadets** across two intakes.
- She recorded their high school rank, SAT scores, Leadership Potential Score (which reflects participation in extracurricular activities), Physical Aptitude Exam and **Grit Scale** (which measures perseverance and passion for long-term goals).



Here's what she found out...

It wasn't strength or smarts or leadership potential that accurately predicted whether or not a cadet would finish Beast Barracks.

Instead, it was grit / mental toughness — the perseverance and passion to achieve long-term goals — that made the difference.

In fact, cadets who were one standard deviation higher on the Grit Scale were 60% more likely to finish Beast Barracks than their peers. It was **mental toughness** that predicted whether or not a cadet would be successful, not their talent, intelligence, or genetics.

When comparing two people who are the same age but have different levels of education, **grit** (and not intelligence) more accurately predicts which one will do better in life and accomplish more.

Talent is Overrated

**“HARD WORK BEATS
TALENT WHEN TALENT
DOESN'T WORK HARD”**
-TIM NOTKE

believe-toachieve.tumblr.com

Mental toughness is a measure of individual resilience and confidence that may predict success in sport, education and the workplace. ... "**Mental toughness**" is frequently used colloquially to refer to any set of positive attributes that helps a person to cope with difficult situations.

[Mental toughness - Wikipedia](https://en.wikipedia.org/wiki/Mental_toughness)

https://en.wikipedia.org/wiki/Mental_toughness

G.R.I.T.



GUTS, RESILIENCE, INITIATIVE, TENACITY

- Mental toughness is built through **small wins**.
- It's the **individual choices** that we make on a daily basis that build our "**mental toughness muscle**."
- There will always be extreme moments that require incredible bouts of courage, resiliency, and grit ... but for 95% of the circumstances in life, toughness simply comes down to **being more consistent than most people**.



I LOVE
REAL ESTATE



PLATINUM

Summary of Angela's Book

1. Grit is a better measurement for success than talent

You can have all the skills in the world, but if you don't know how to apply them and survive the long haul, you'll most likely never succeed

2. High performance comes from mundane acts

We're programmed by society to embrace the idea that natural talent leads to our own greatness. This myth is promoted because it lets us all off the hook and allows us not to have to work too hard. The reality couldn't be further from the truth.

By adding up thousands of mundane acts repeated over and over, we have the fuel we need to accomplish our goal.

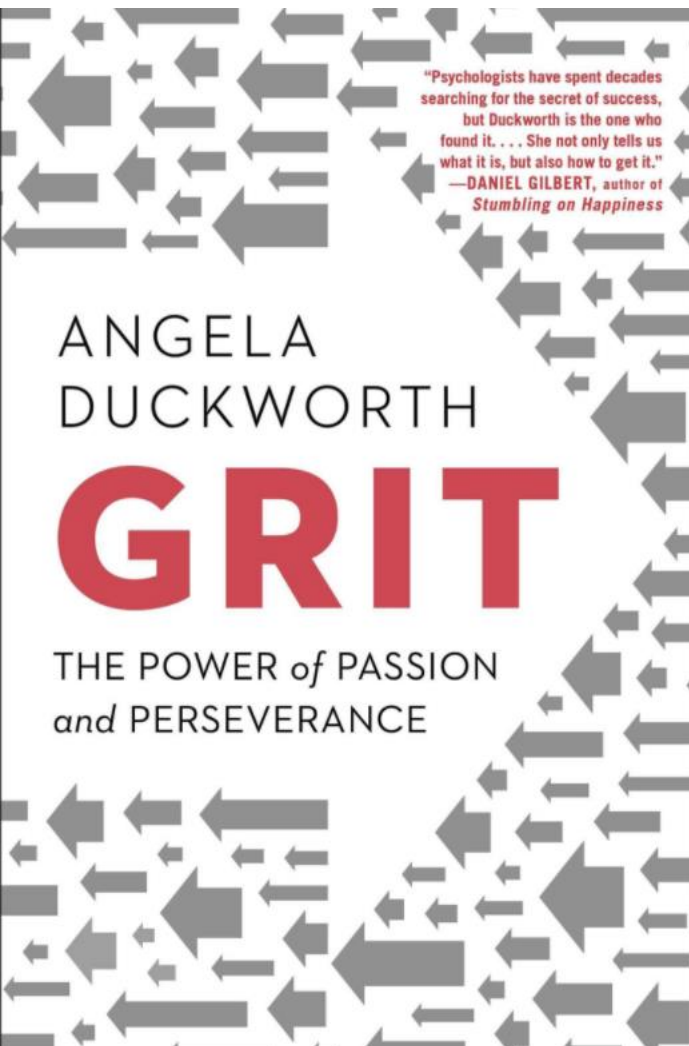

Summary of Angela's Book con't

3. Grit is about stamina not intensity

We can all be good at a task for a day. We can all give it all we've got for twenty-four hours and work harder than we ever have before. But, if we're only going to work hard at this task for a day and then not keep repeating the process regularly, then we will never reach our goal.

4. Decide what not to do

Success is about minimalism in the sense that it's what we choose not to do that is often more important than what we do. We have limited time and resources, so the way we funnel them both into certain activities will determine our long-term outcome.

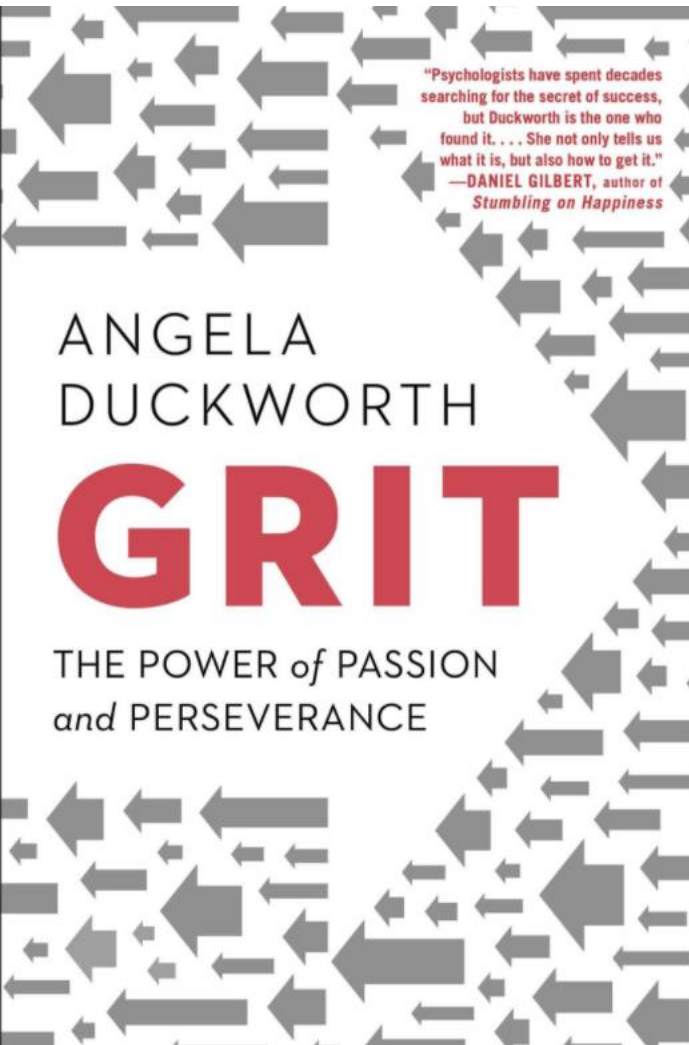

Summary of Angela's Book con't

5. Purpose is the idea that what we do matters

It's the effect that we have on other people that often fuels our purpose further. **Through the study of people that have grit, what we know is that they're all able to find purpose beyond themselves.**

6. The way you deal with failure determines your success

It's the people who try a few different ways and then stop the practice of searching that fail. **Dealing with failure is about taking ownership of your problem and making yourself responsible for solving them.** At the same time, you can always ask others for a helping hand as long as you are taking the lead.

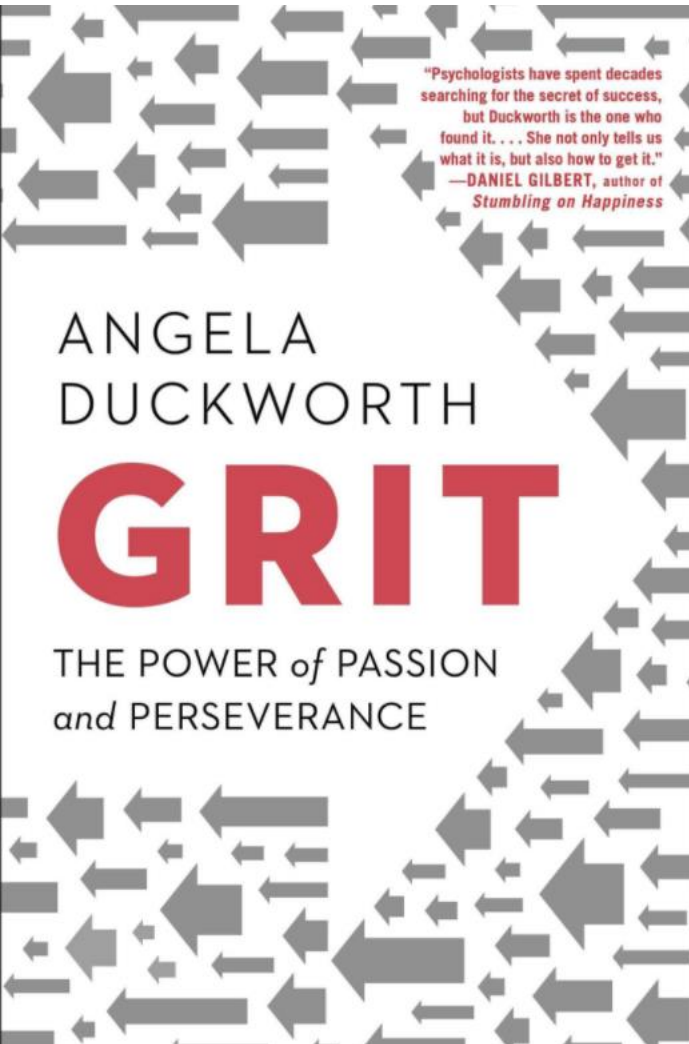

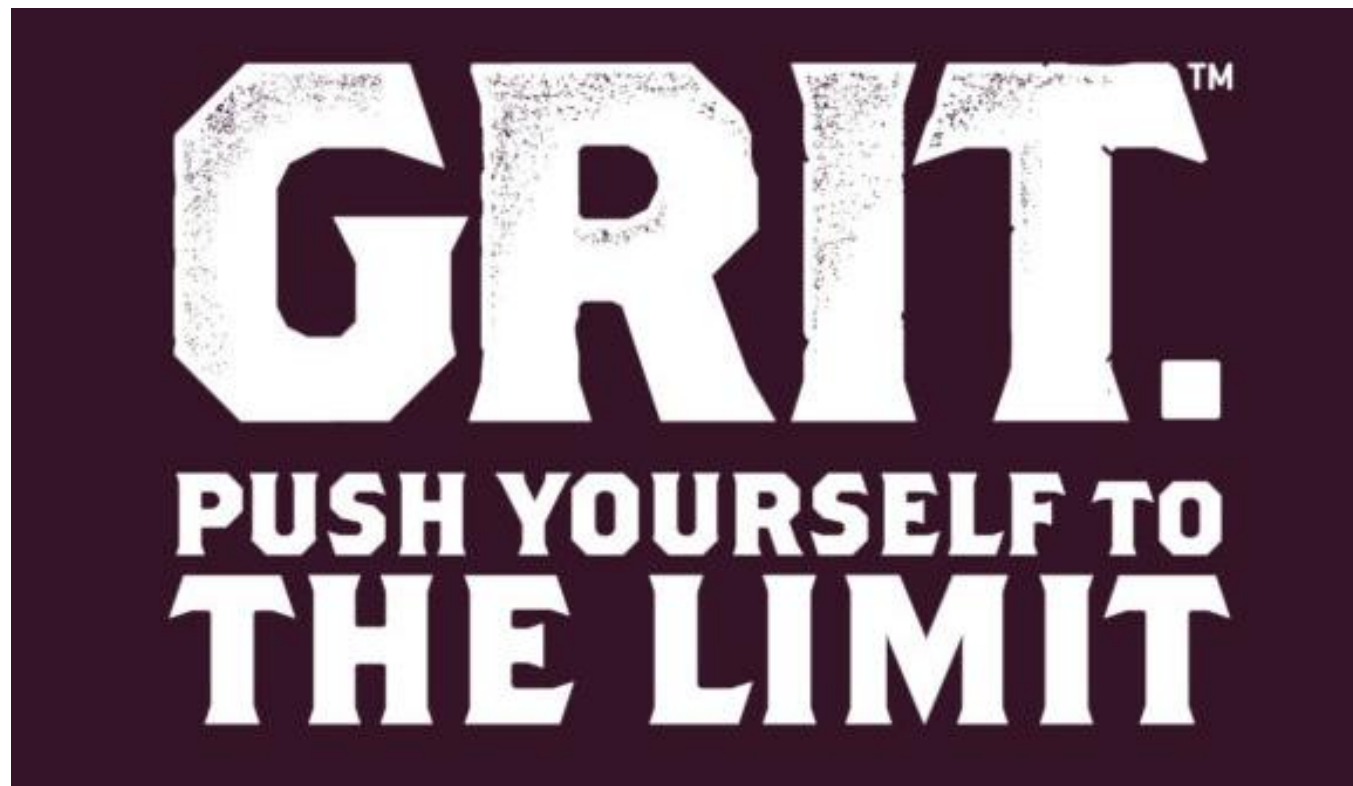

Life is about constant improvement and striving for the top of the mountain. Even when you reach the top, there is always a bigger mountain to try next time around. **The only constant between success and failure is courage.** As long as you have the courage, you'll keep getting back on the horse and trying again.



Define and discuss **what Mental Toughness means to you?**

What commitment can you make right now to start your road to greater mental toughness?

WHETHER YOU
THINK YOU CAN,
OR THINK YOU CAN'T,
YOU'RE RIGHT.

PLATINUM

Accountability Monthly Goals



I LOVE
REAL ESTATE

Buddy Process Follow-Up



PLATINUM

ROOMING ACCOMMODATION

PLAN READING & MODIFICATION



I LOVE
REAL ESTATE

Reading Plans

VERY IMPORTANT SKILL

Architectural Plan Set



- Site Plan
- Floor Plan
- Elevation Plans
- Cross Section Plans
- Window & Door Plan
- Plumbing & Roof Plan
- Electrical Plan
- 3D Plans



onplan pty ltd
PAUL CURRIE 0410 960 060 fax 5491 8586
IAN MCKINNON 0411 524 520 fax 5490 2214
central@onplan.com.au
po box 215, middle beach qld 4201
china 1123550
usa 1 26 106 920 usa 26 644 351 888

client

1 preliminary 1 04/06/08
2 approval 20/06/08
3 approved for plans 26/06/08

date april 2009
job no. 0622
scale 1:50

drawn by 127
checked by B
initial

sheet name 3d views
issue approval

Reading Floor Plans

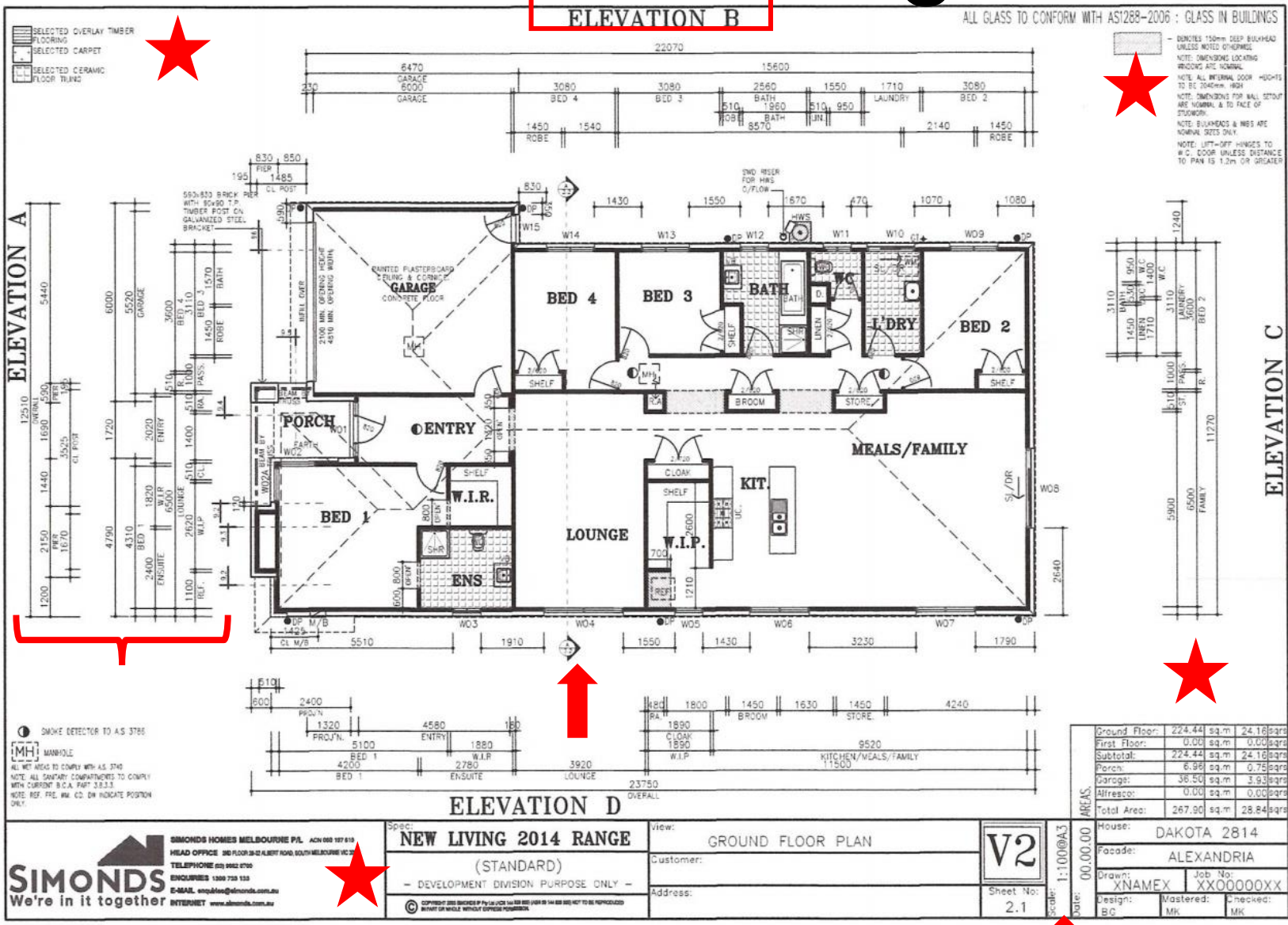

- Title block – Note amendment date
- Scale
- Notes
- Area measurements
- Dimensions
- Elevation notation
- Cross section points
- North Arrow – Site plan
- Floor coverings



PLATINUM

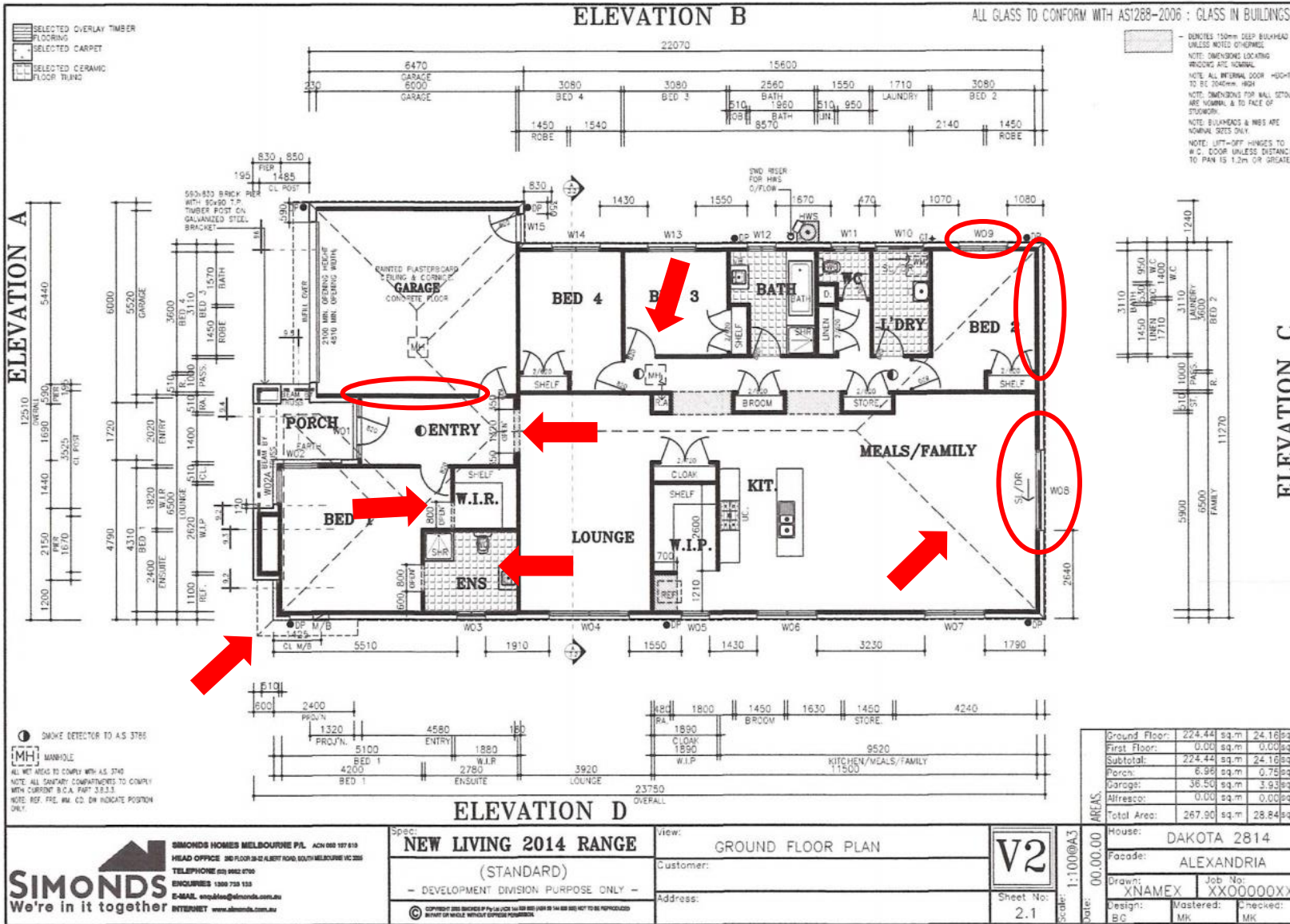

- **Walls** – External & Fire Rated = thick line. Internal = thin line, dotted lines = head / bulk head
- **Roof** – Eaves, roof line, ridge/valley lines
- **Windows (W) & Doors (SD)**
- **Wet areas** - Hatching
- **Door swing** vs cavity slider

Activity: Abbreviations – Find & Name

- WC – Water closet (toilet)
- MW – Microwave, UBO – Underbench oven, CT – Cooktop, RH – Range hood, DW – Dishwasher
- WM – Washing machine
- HWS – Hot water system
- DP – Downpipe
- WIR – Walk in Robe
- MH – Man hole
- POS – Private open space
- Others?

ELEVATION B ALL GLASS TO CONFORM WITH AS1288-2006 : GLASS IN BUILDINGS

ELEVATION A

ELEVATION C

ELEVATION D

SELECTED OVERLAY TIMBER FLOORING
SELECTED CARPET
SELECTED CERAMIC FLOOR TILING

SMOKE DETECTOR TO A.S. 3786

MAN-HOLE

ALL MET NEED TO COMPLY WITH A.S. 2742

NOTE: ALL SCHEDULED COMPONENTS TO COMPLY WITH CURRENT B.C.A. PART 3.8.3.3

NOTE: REF. FPE, IM, CM, DN INDICATE POSITION ONLY.

AREAS	Area	sq.m	sq.ft
Ground floor	224.44	sq.m	24.18sqft
First floor	0.00	sq.m	0.00sqft
Subtotal	224.44	sq.m	24.18sqft
Porch	6.96	sq.m	0.75sqft
Garage	38.50	sq.m	4.16sqft
Alfresco	0.00	sq.m	0.00sqft
Total Area	267.90	sq.m	28.84sqft

House: DAKOTA 2814
Facade: ALEXANDRIA
Drawn: XNAMEX Job No: XX000000XX
Design: BC Mastered: MK Checked: MK

Spec: NEW LIVING 2014 RANGE (STANDARD)
- DEVELOPMENT DIVISION PURPOSE ONLY -
© COPYRIGHT 2004 SIMONDS PTY LTD. ALL RIGHTS RESERVED. FOR IN THE USA SEE US AT THE REPRESENTATIVE OF WHOLE RETAILER OFFICE FOURMILE

view: GROUND FLOOR PLAN
Customer:
Address:
Sheet No: 2.1
Scale: 1:100@A3
Date: 00.00.00

SIMONDS We're in it together
SIMONDS HOMES MELBOURNE PTY. LTD. ACN 089 197 819
HEAD OFFICE: 360 FLOOR 36-42 ALBERT ROAD, SOUTH MELBOURNE VIC 3204
TELEPHONE: 03 9483 8700
ENQUIRIES: 1300 738 133
E-MAIL: info@simondshomes.com.au
INTERNET: www.simondshomes.com.au



Plan Modification

- Benefits of being able to modify existing plans?

- ❖ **Easier to quote** off a plan than an idea
- ❖ Easier for drafts person to **work off an example**
- ❖ Helps you to **visualize end result** (room sizes etc.)
- ❖ Helps you to **communicate with others** – PM, agents, builders

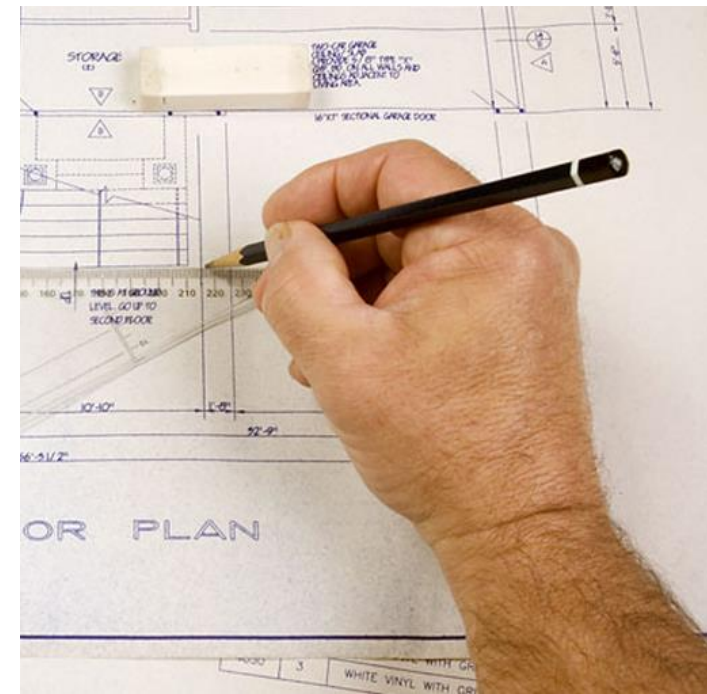

Considerations with Plan Modifications

1) Town Planning Requirements:

- ❖ Zoning, Land size, Frontage, Overlays, Usage - Granny flat, Rooming house, Motel

2) Building Code Requirements:

- ❖ Class of Building – 1a, 1b, 3
- ❖ Building Standards – Habitable Room (Light, Ventilation, Slab thickness etc.)

3) Building Constraints:

- ❖ Load bearing walls
- ❖ Slab thickness – Habitable rooms (garage conversion)

4) Market Requirements: Room sizes (3x3 vs 4x4.5), living, parking etc.

Work In Rectangles

Work in Rectangles - fill in detail later

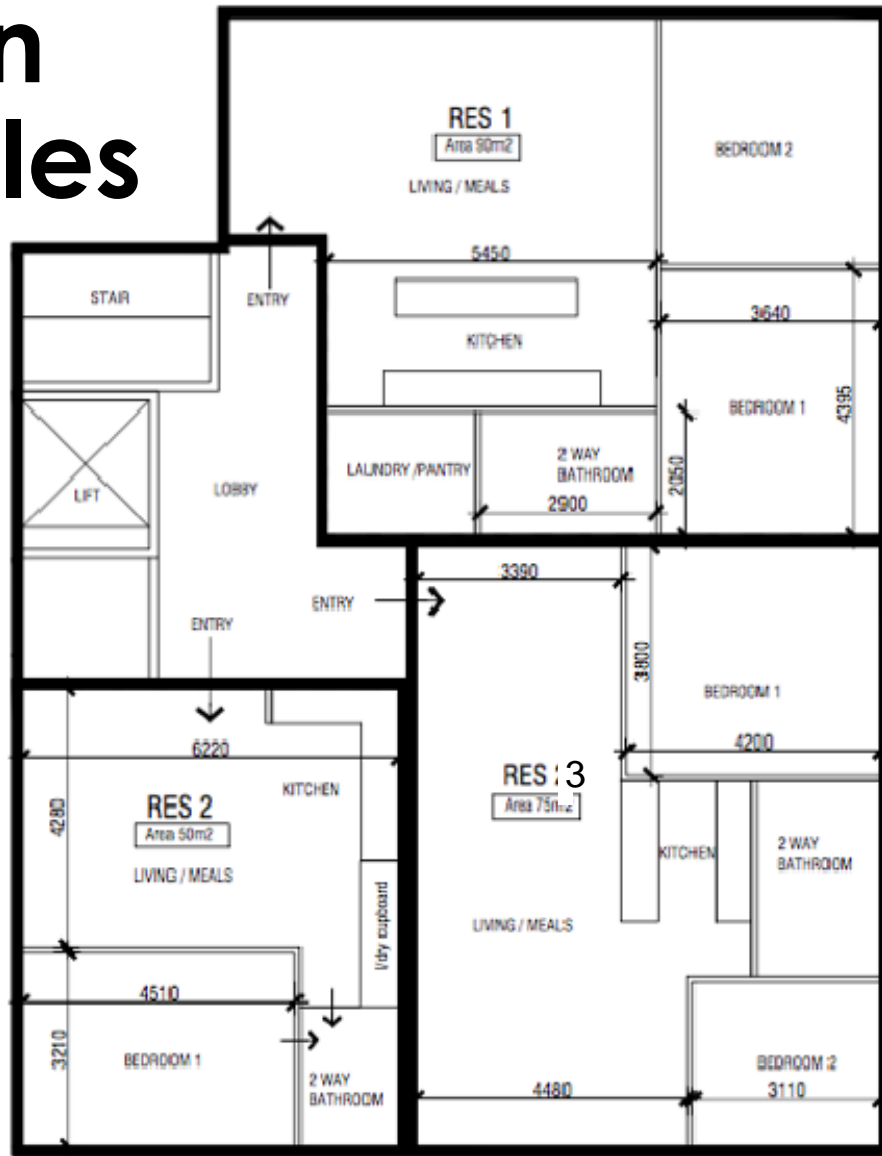

Standard Dimensions

- Bathroom – Min 2.4m x 2.4m (Shower/bath/vanity)

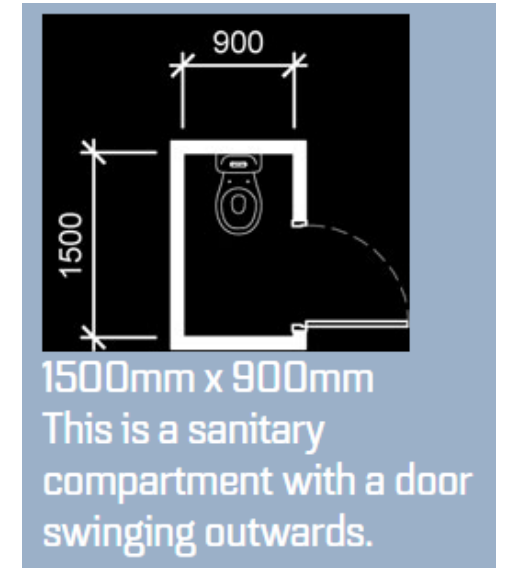
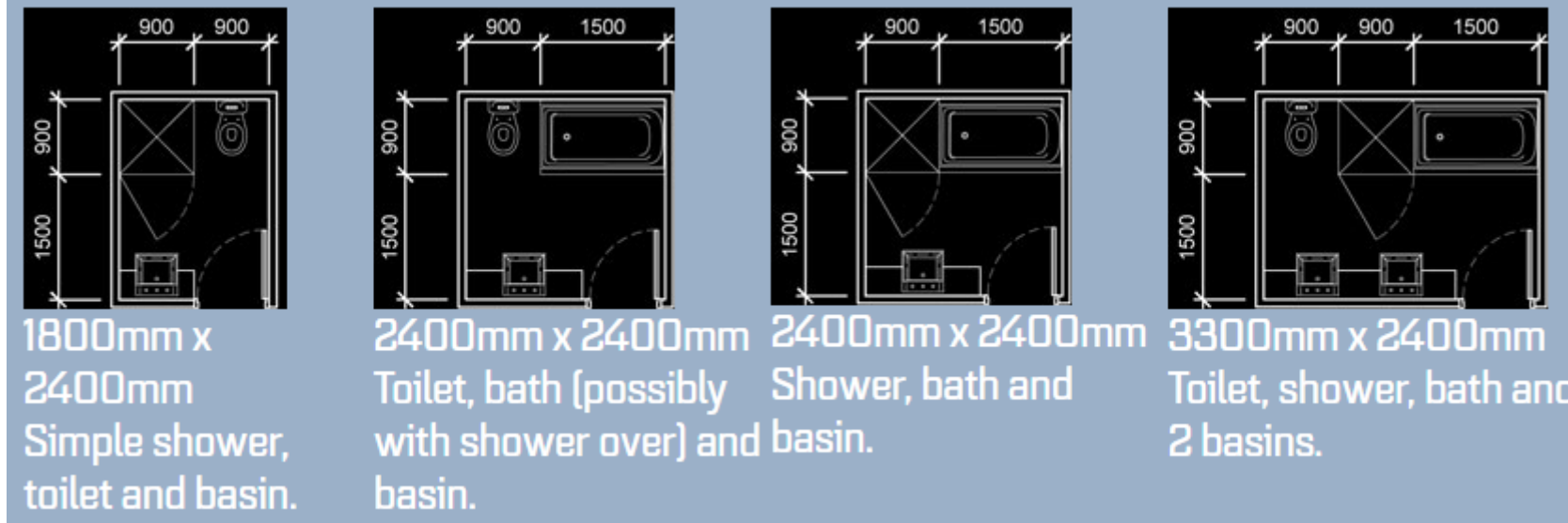

- Pencil Ensuite – 1.2m x 3m (shower/toilet/vanity)
- Toilet – Min 900mm wide x 1.5–1.8m long depending on door type
- Shower – Min 900mm x 900mm

http://www.thirdistudio.com.au/What_Are_Common_House_Room_Sizes.html

Standard Dimensions

- **Laundry** – Standard Min 1.8m x 2.1m; Cupboard 900mm deep

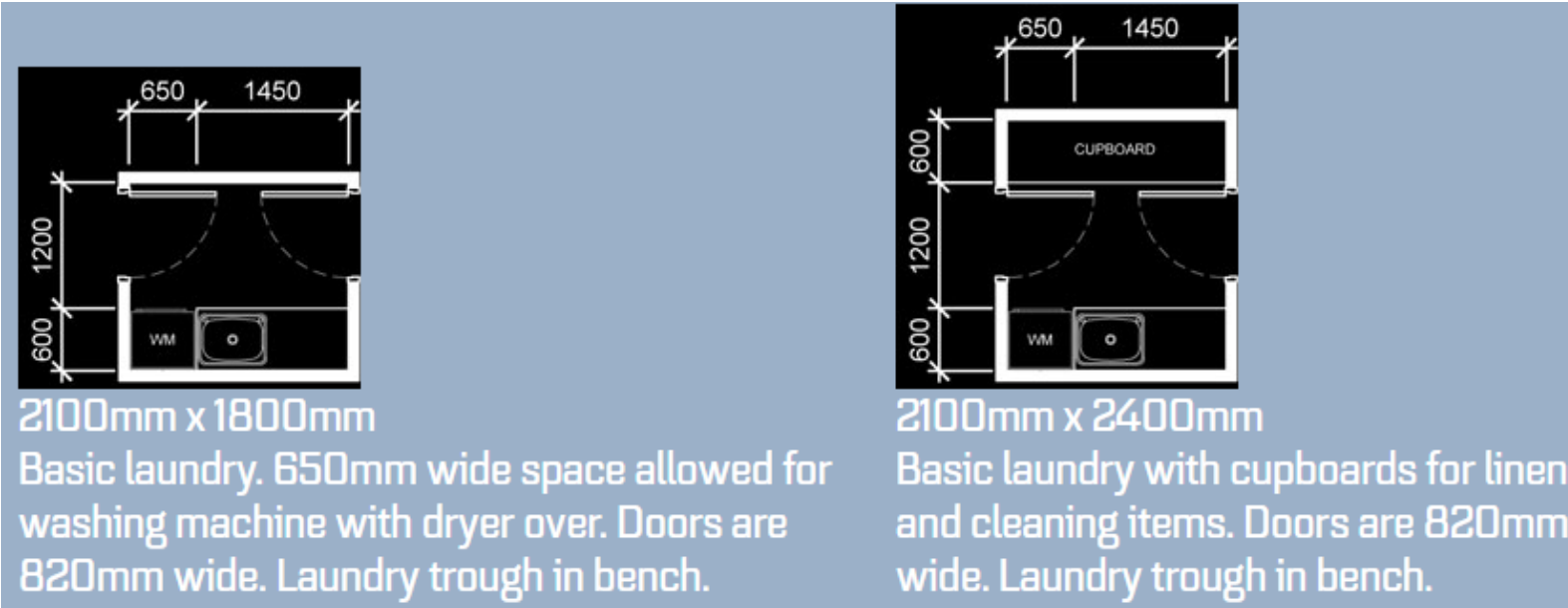

- **Hallway** – Min 900mm wide
- **Swing Door** – 820mm

http://www.thirdistudio.com.au/What_Are_Common_House_Room_Sizes.html

Standard Dimensions

- **Bedroom** – Min 3m x 3m excl. built in robe
- **Robe / Linen / Broom** – 600mm deep
- **Study** – Min 2.4 x 2.7m

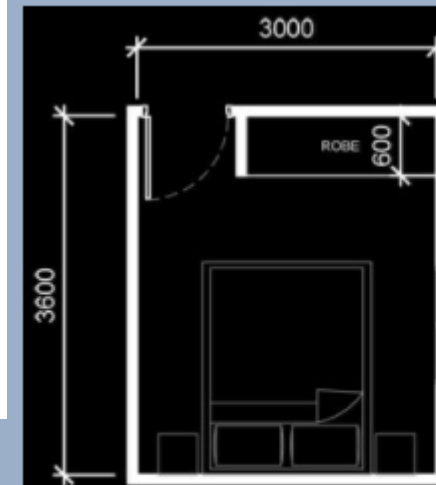

3000mm x 3600mm

Very basic bedroom layout which allows for a built in robe and space for a queens sized bed and 2 side tables. I wouldn't recommend anything smaller than this.

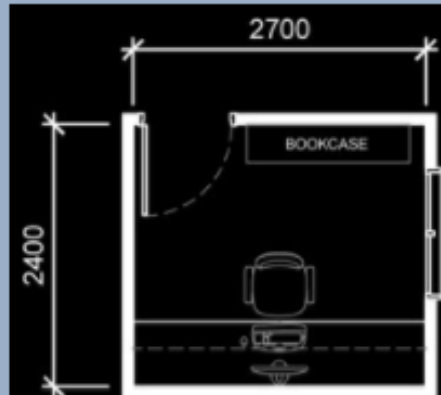

2400mm x 2700mm

Basic small study / home office. Allows for a built in workbench, and enough room for a bookcase.

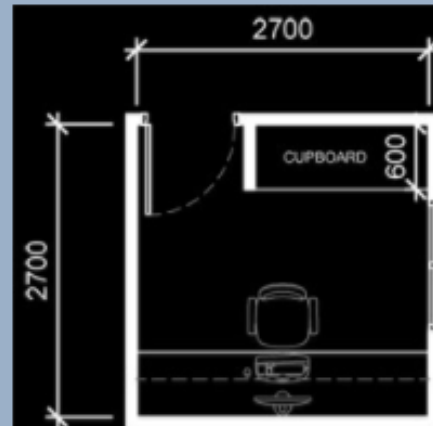

2700mm x 2700mm

Medium sized study / home office. Allows for a built in workbench and built in cupboards.

http://www.thirdistudio.com.au/What_Are_Common_House_Room_Sizes.html

Standard Dimensions

- **Kitchen** – Min 2.4m x 3m; Min 900mm between benches
- **Walk In Pantry** – Min 1.5m wide

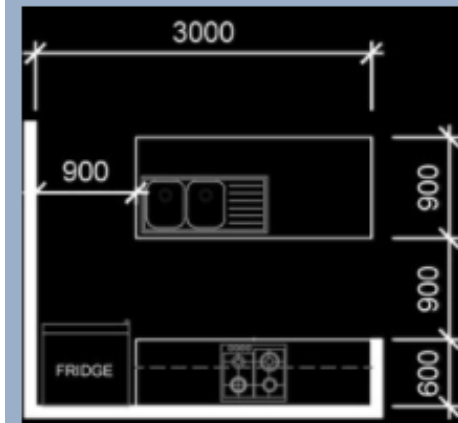

2400mm x 3000mm

Very small kitchen with an island bench. Oven under cooktop, overhead cupboards. Note that there is very little cupboard space for both dinnerware, glasses etc and food storage in this layout.

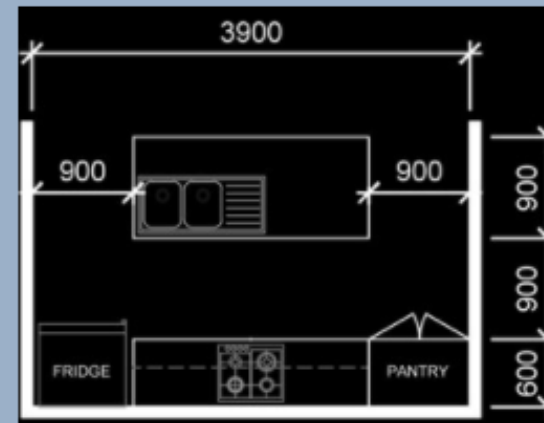

2400mm x 3900mm

Similar to the previous layout except there is now room for a dedicated pantry. The pantry could also house the microwave.

- **Garaging** - DLUG – 6m x 6m; SLUG 6m x 3m

http://www.thirdistudio.com.au/What_Are_Common_House_Room_Sizes.html

Standard Dimensions

- Lounge – 3.3m x 4.2m depending on furniture

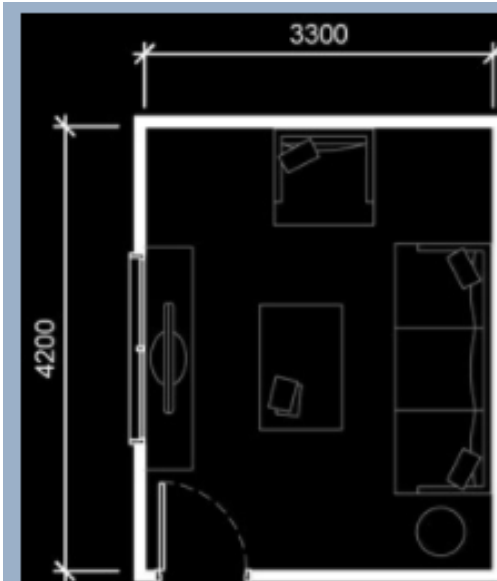

4200mm x 3300mm

Very small living space in my opinion. You could make it work, but I think it would make the space cramped in a space with enclosed walls.

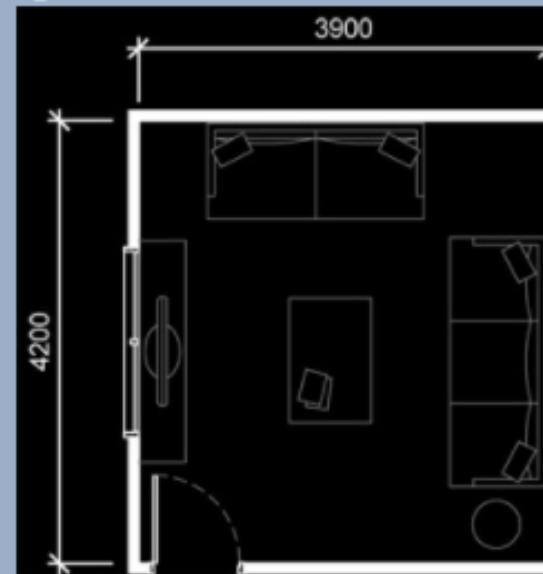

4200mm x 3900mm

Quite a basic space allowing for one 3 seater couch and one 2 seater couch. Slightly more spacious than the previous layout allowing for more leg space between couches and table.

http://www.thirdistudio.com.au/What_Are_Common_House_Room_Sizes.html

Standard Dimensions

- **Stairs** – Min 1050mm wide; 1200mm recommend (moving furniture)

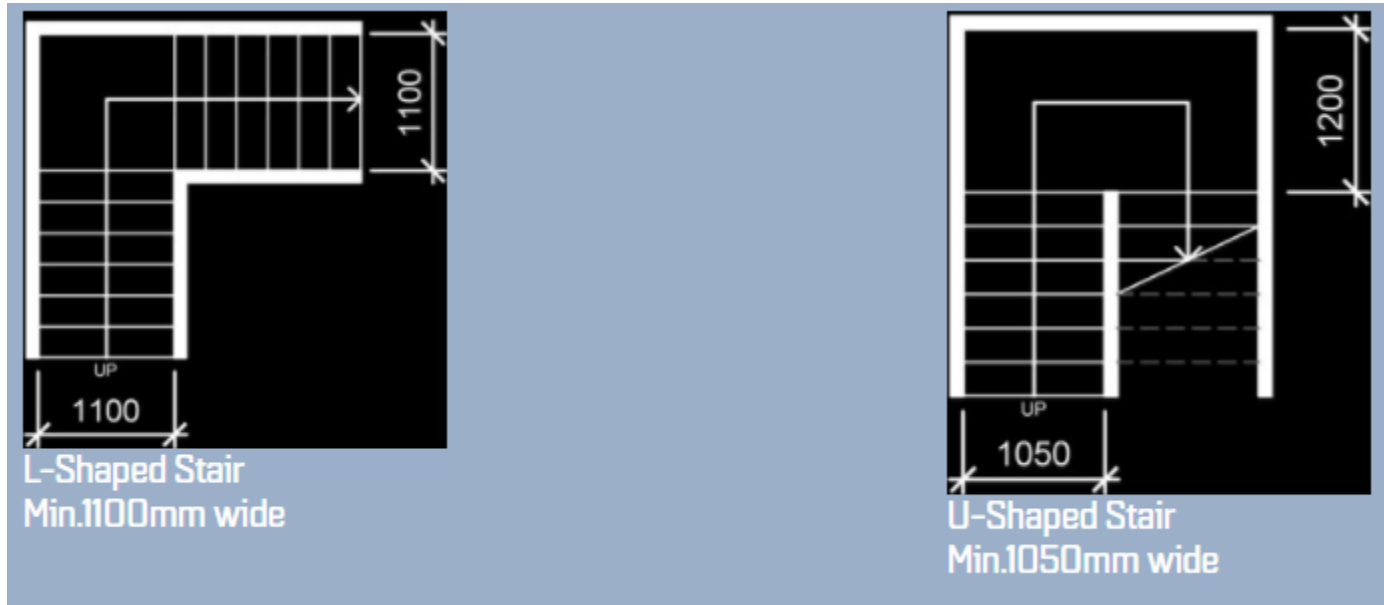

http://www.thirdistudio.com.au/What_Are_Common_House_Room_Sizes.html

Activity 1 – 4 Bedroom Plan into Rooming Accommodation

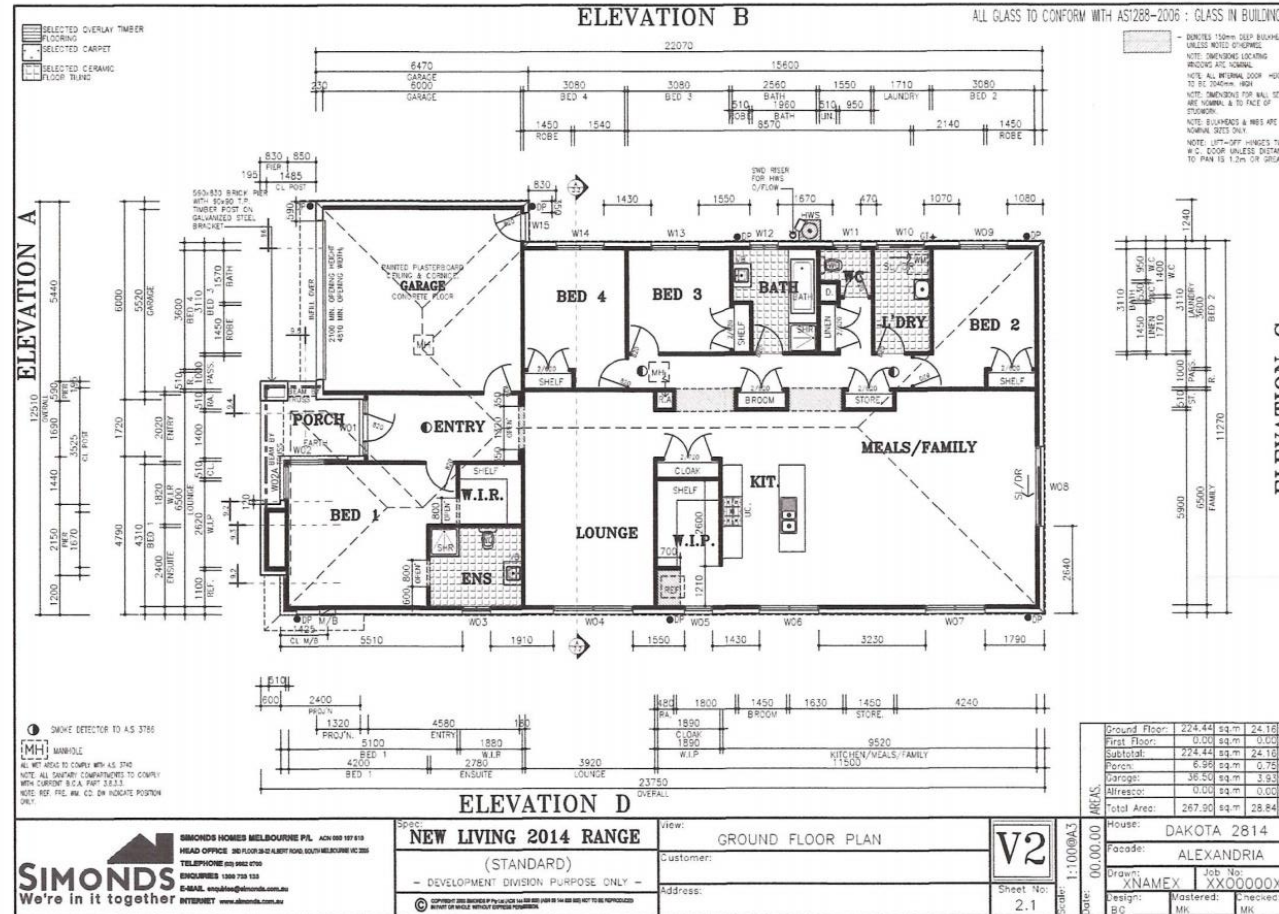

Activity 1 –

Rooming House (Class 1b) – Victorian SPECIFICATIONS

- Max 8 bedrooms / house
- Max 12 residents / house
- Min 1 bath or shower & basin per 10 people!!
- Min 1 disabled bathroom & bedroom / house
- Min bedroom size = 7.5m²
- Min bedroom size for couple = 12m²
- Kitchen = Min 400L fridge capacity, Lockable cupboard min 100L storage per resident, Min 4 burner cooktop + oven, sink & food prep area
- Option to include kitchenette in bedroom = Min 80L fridge, cupboard min 100L storage capacity, oven, cooktop, sink, food prep area

Activity 1 – 4 Bedroom Plan into Rooming Accommodation

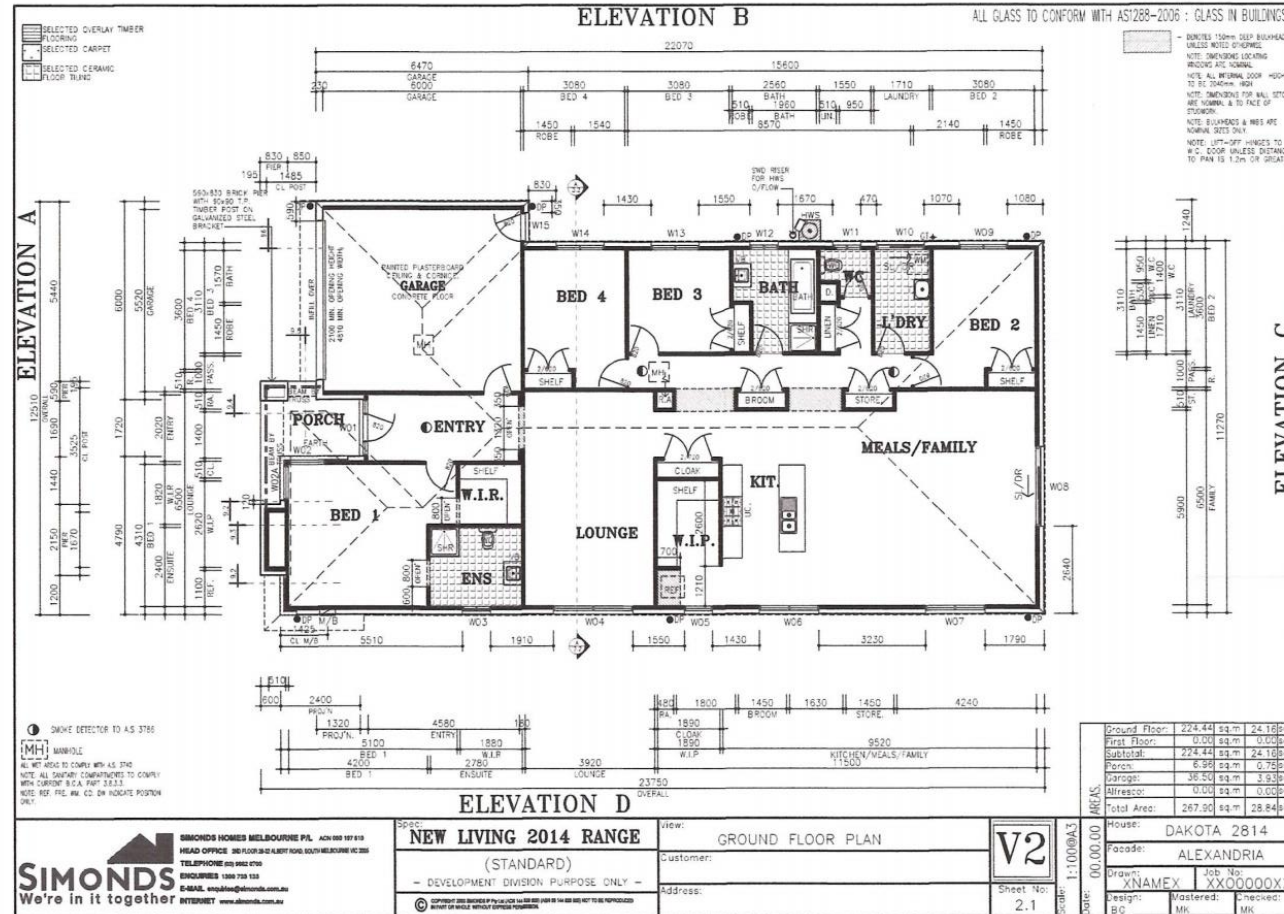

Assume the house hasn't yet been built!

4 Bedroom Plan into Rooming Accom - Option 1

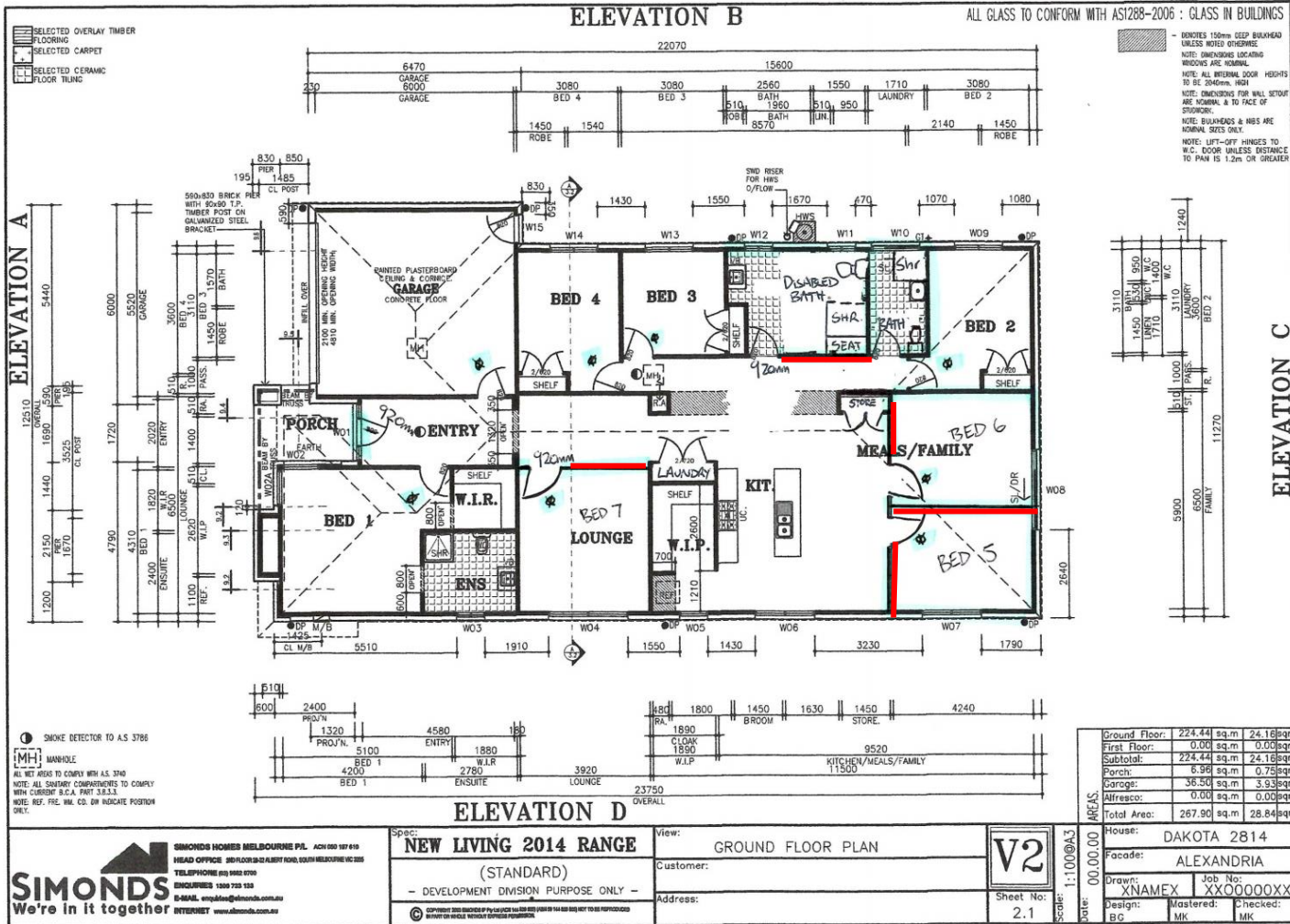

- 1) Converted lounge & meals/family into 3 bedrooms (5, 6, 7)
- 2) Made Bedroom 7 disability accessible with 920mm door
- 3) Converted bathroom & separate toilet into disabled bathroom
- 4) Converted laundry into second bathroom
- 5) Converted cloak/linen cupboard into laundry
- 6) Replaced entry door with 920mm opening for disability access
- 7) Added smoke alarms to all bedrooms



OTHER IDEAS?

Activity 2 – 5 Bedroom into House + Granny Flat

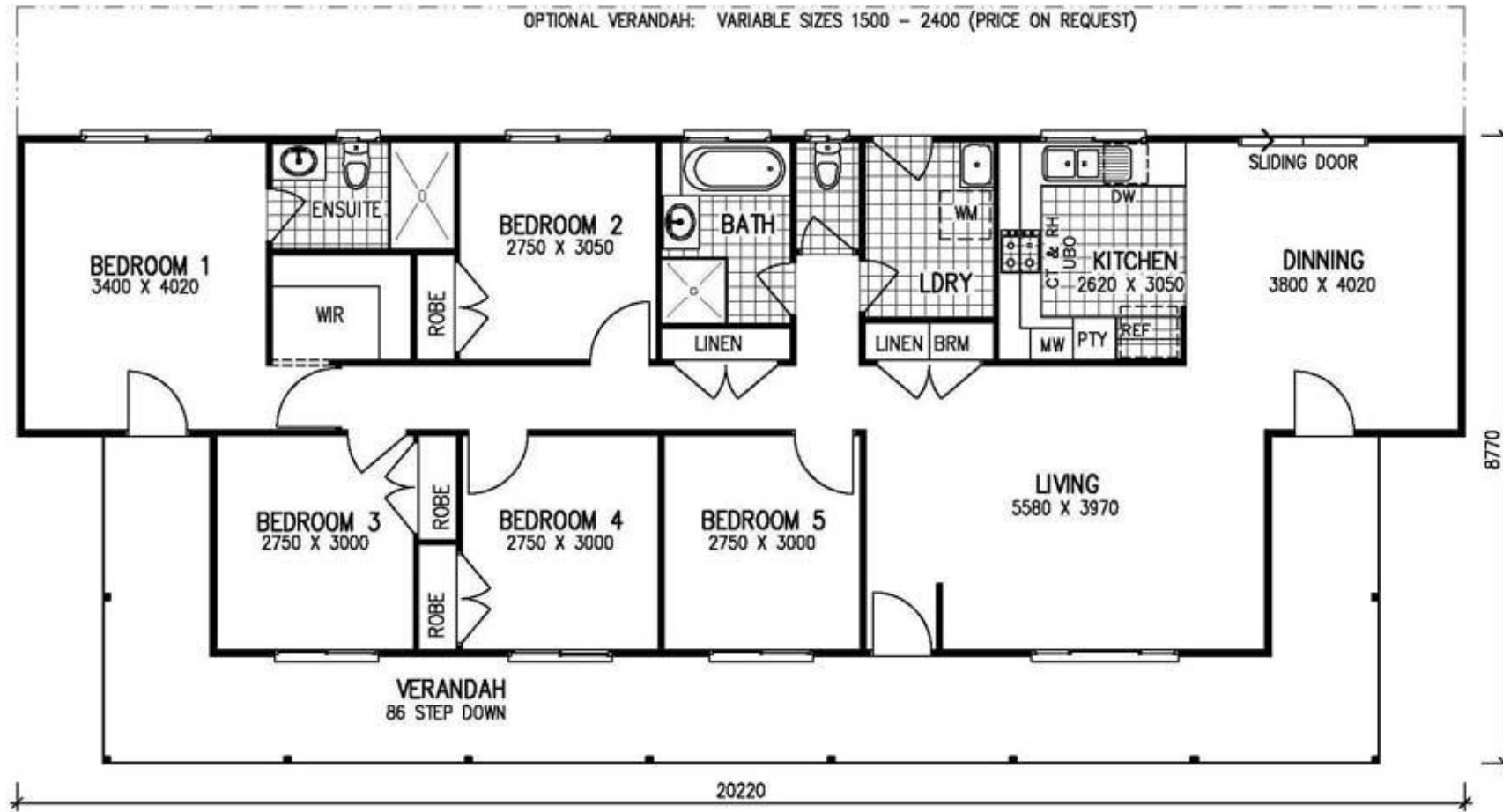

Activity 2 – 5 Bedroom into House + Granny Flat

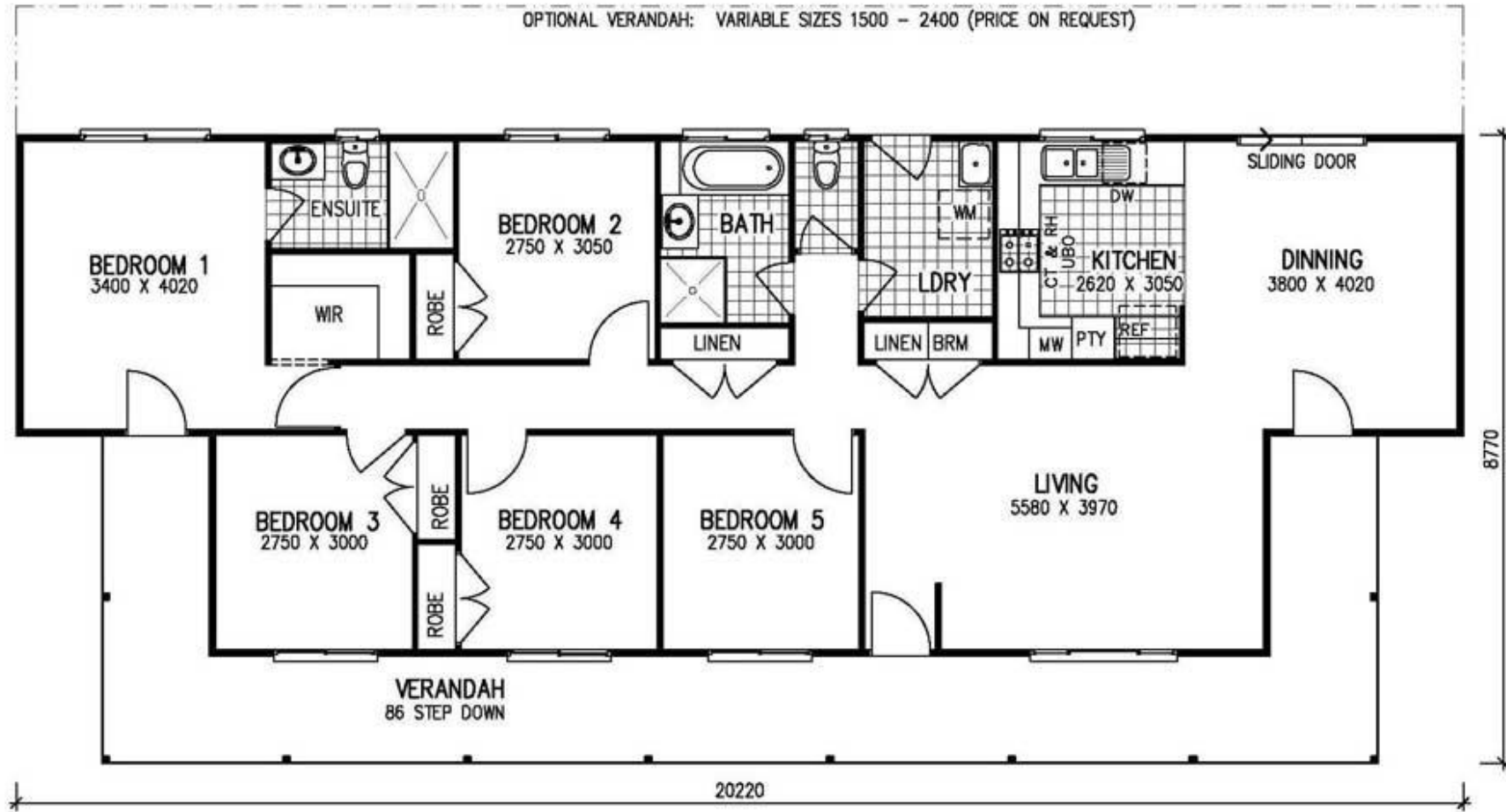

Granny Flat CONSIDERATIONS:

- External Size
- No. Bedrooms
- POS
- Car parking
- Distance from main house
- Fire separation
- Laundry = Fully self contained

5 Bedroom into Granny Flat Option 1

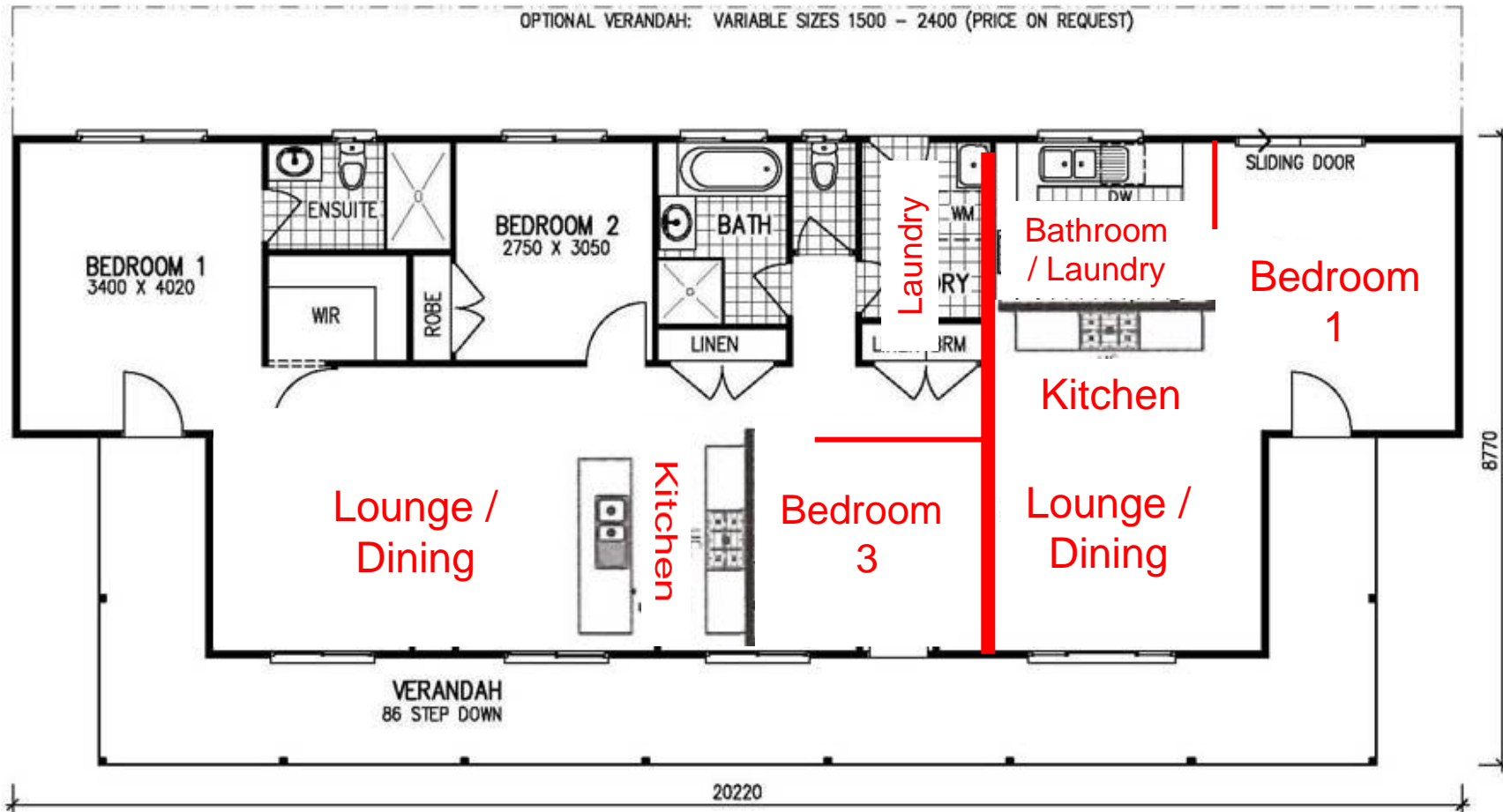

5 Bedroom into Granny Flat Option 2

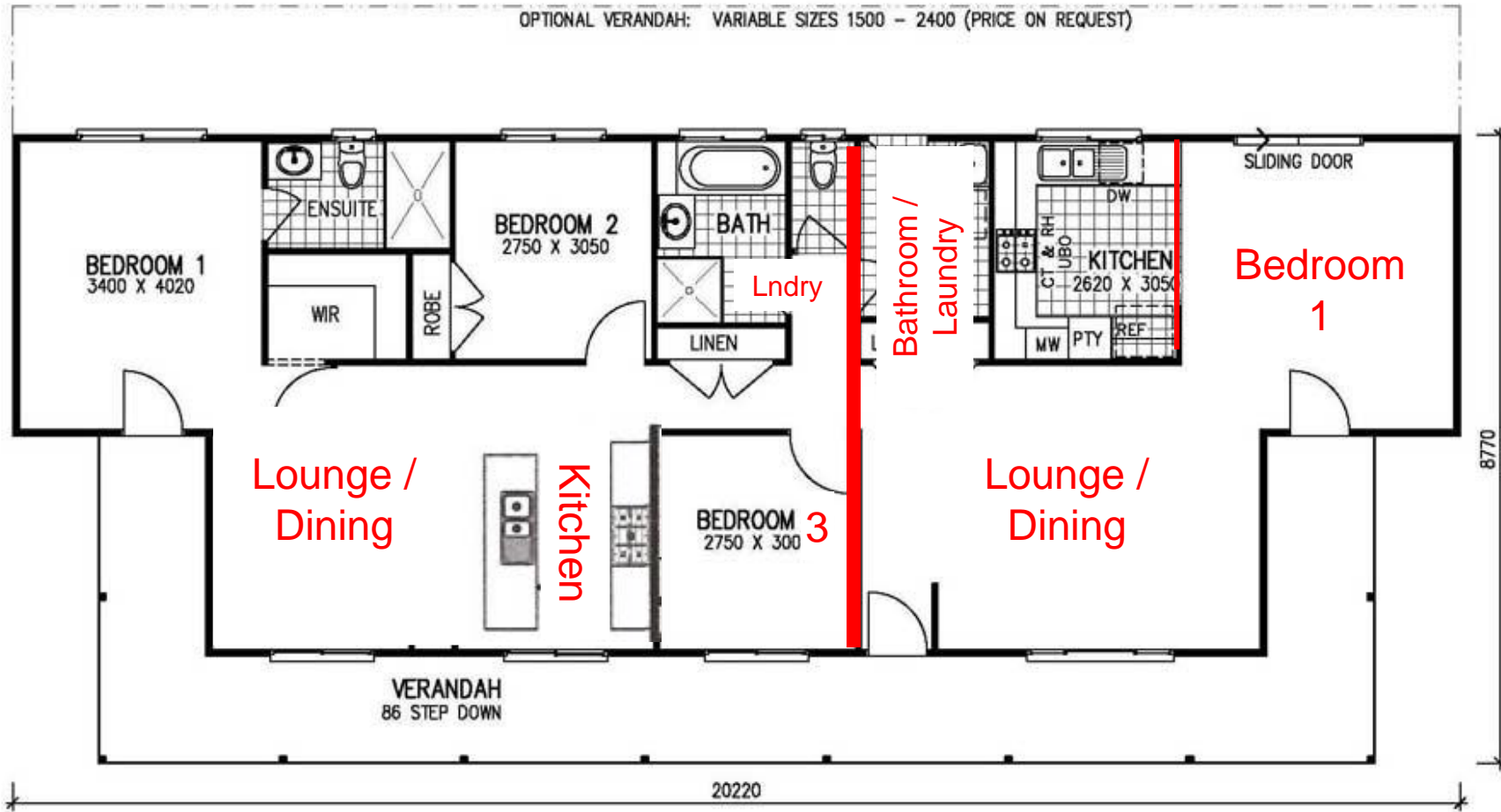



OTHER IDEAS?

Activity 3 – Motel into Higher Yielding Motel

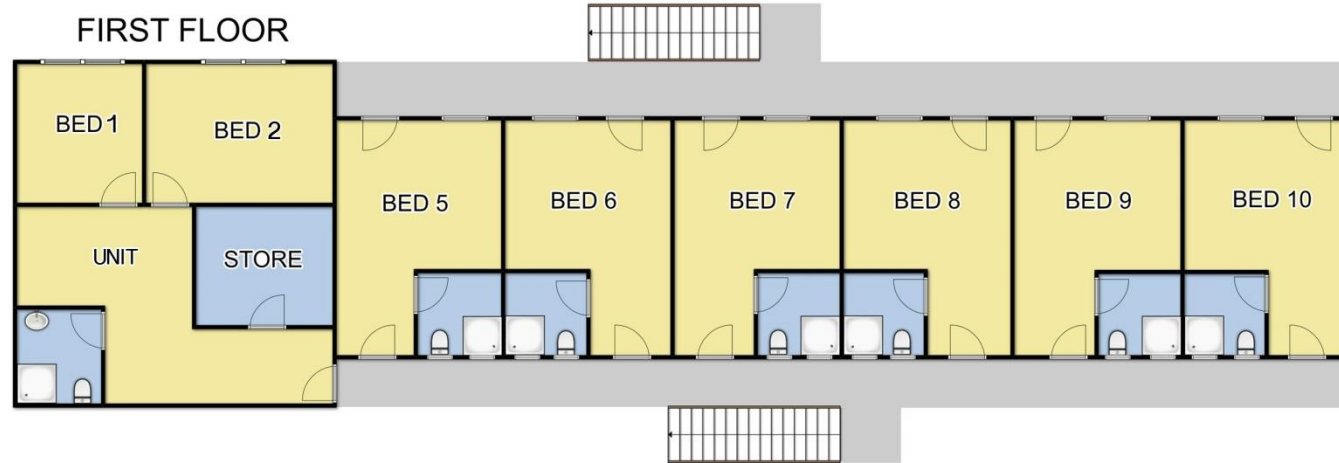

STARTING

- 1) 10 Ensuated bedrooms
- 2) Managers suit downstairs
- 3) 2 Bedroom unit upstairs
- 4) Reception/Office, Kitchen, Dining, Living, Store

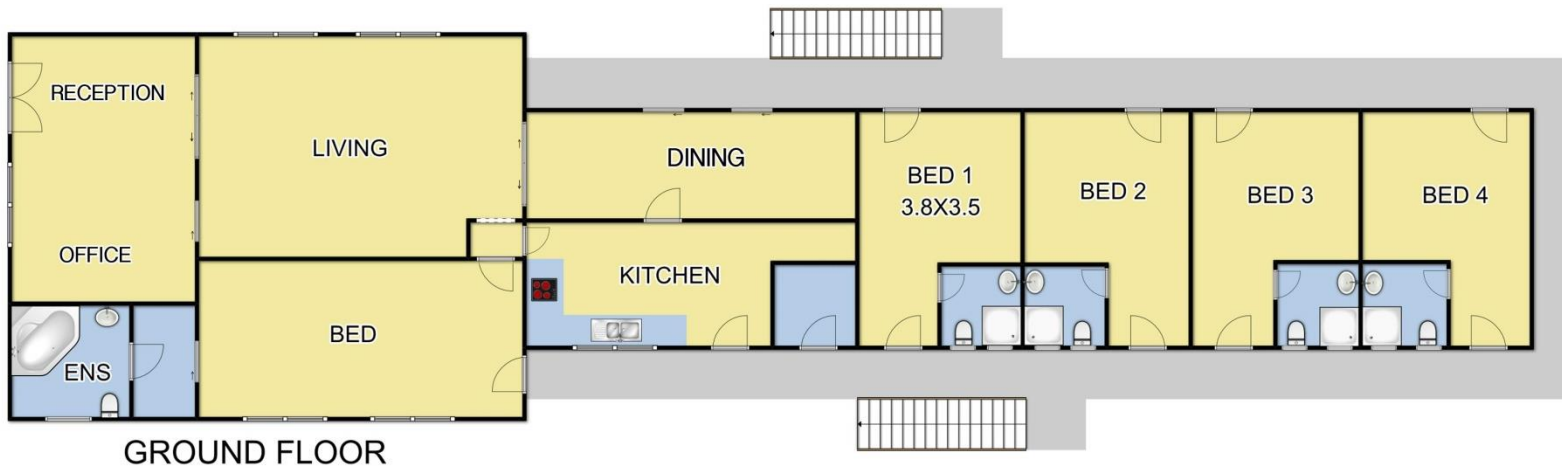

Activity 3 – Motel into Higher Yielding Motel



Motel CONSIDERATIONS:

- Room size
- No. bedrooms
- 1brm vs 2brm
- Reception, Office
Kitchen, Storage,
Dinning, Lounge,
Manager accom
needs
- Access & parking

Activity 3 – Motel into Higher Yielding Motel



Motel

SPECIFICATIONS:

- Increase number of ensuited bedrooms
- Need reception / office, kitchen, store, managers accom.

Assume the motel is already built!

Activity 3 – Motel into Rooming Accommodation

Option 1



- 1) 15 Ensuated Bedrooms
- 2) Managers suit downstairs
- 3) Kitchen & storage location retained
- 4) Bathroom added to kitchen

Activity 3 – Motel into Rooming Accommodation

Option 2



- 1) 15 Ensuated Bedrooms
- 2) Compact Manager bedroom downstairs
- 3) Moved kitchen & storage
- 4) # 14 = Double bedroom upstairs



OTHER IDEAS?

QUESTIONS?